

VOLANTES | VOLANTS | WHEELS | VOLANTES

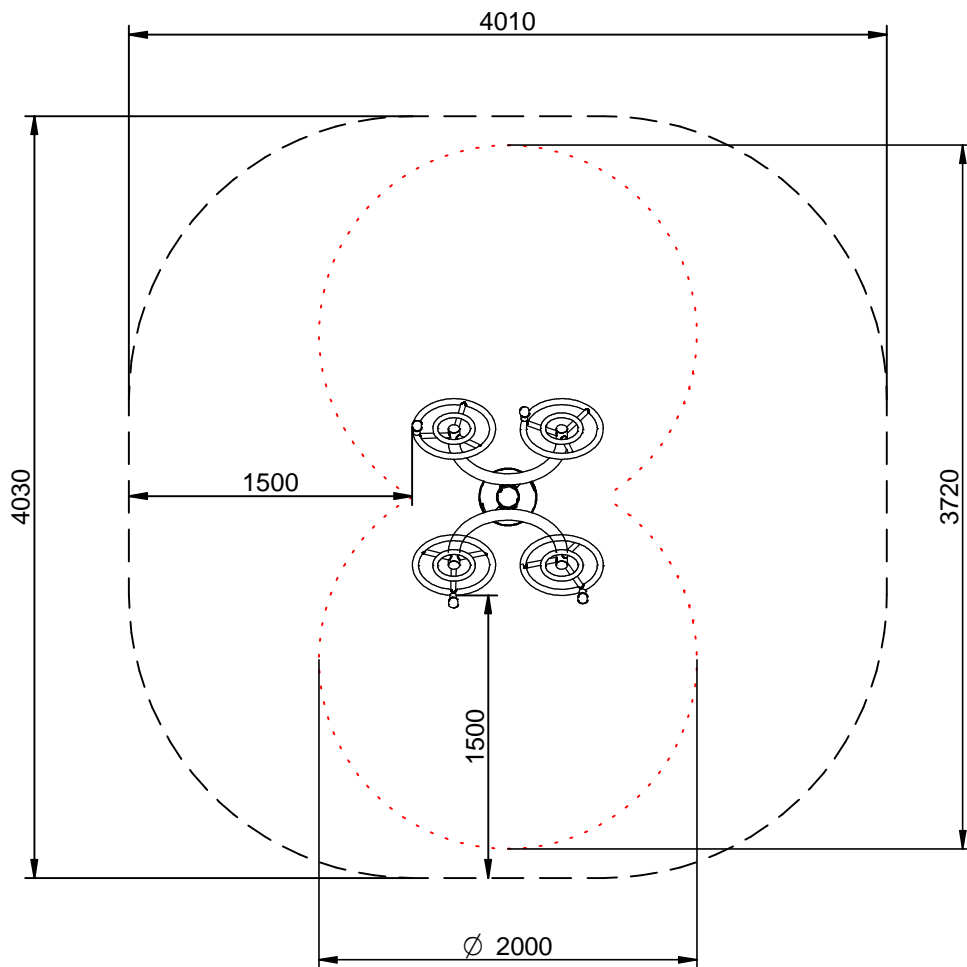
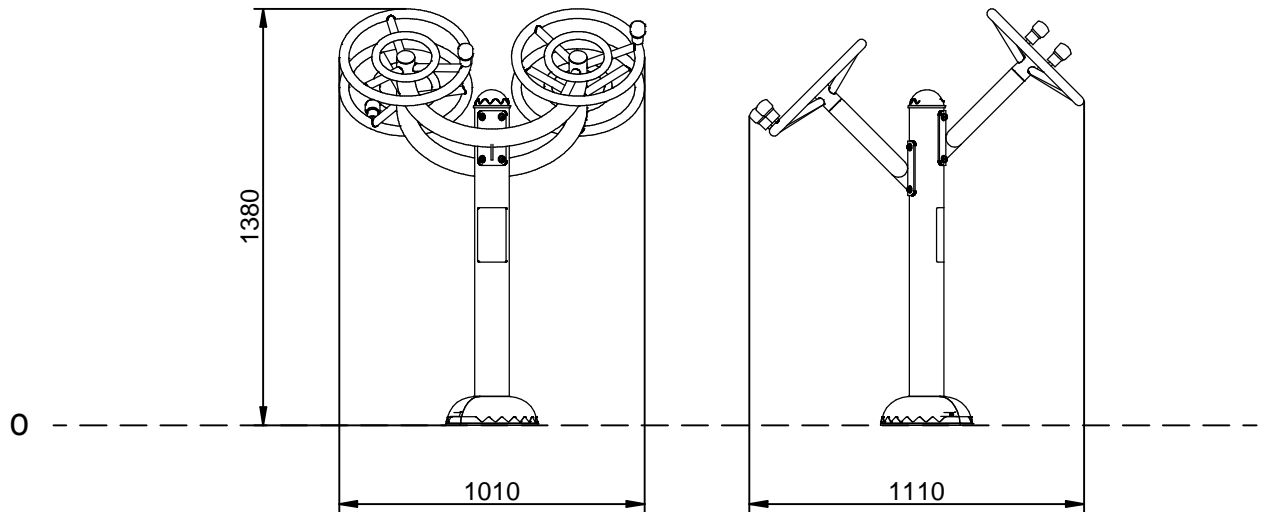

Stotal = 14,30 m² H= 0 m

V 02.05/03/2018